

WISSOUS 44 5X3

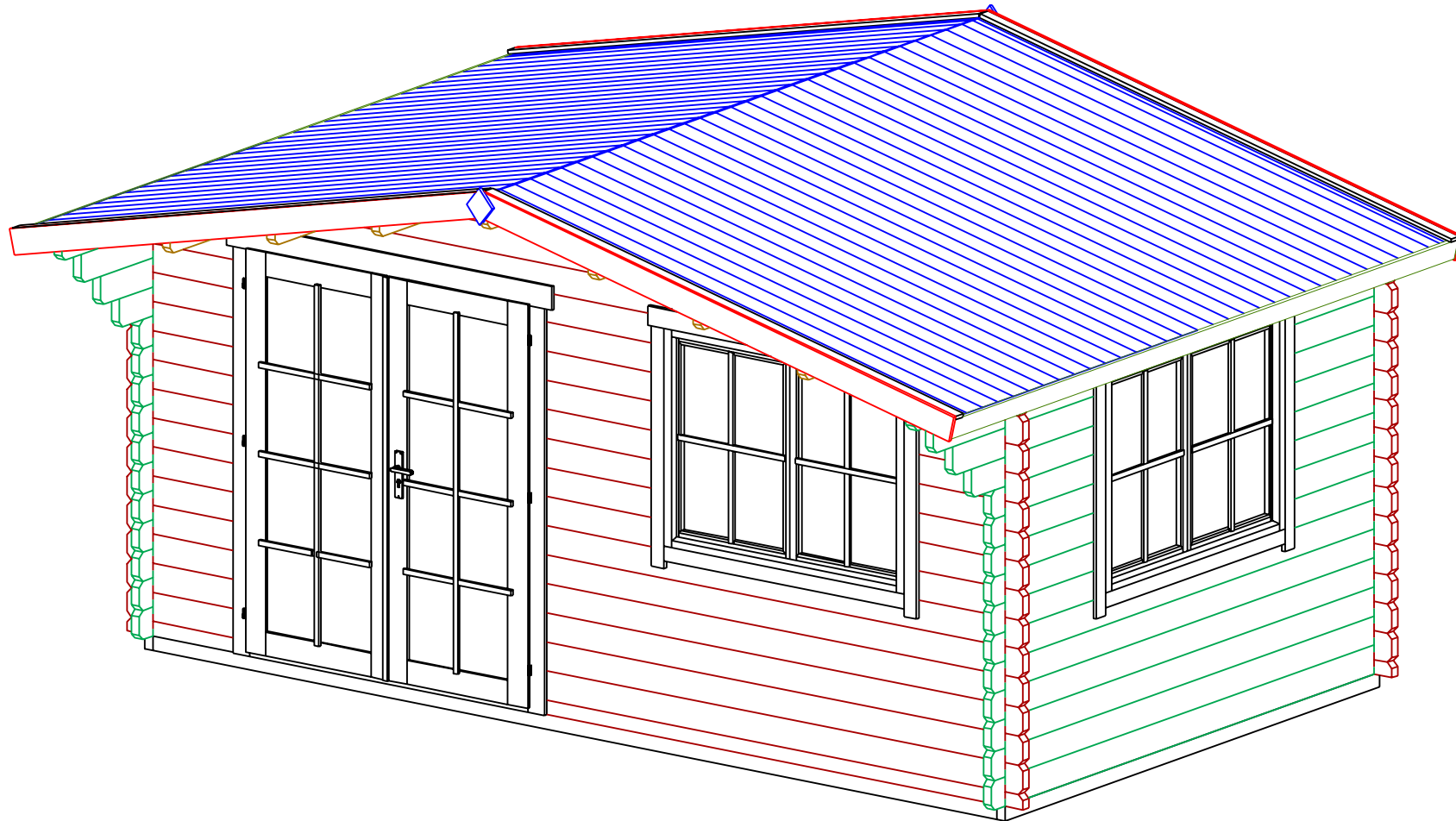

Wissous 44 5X3

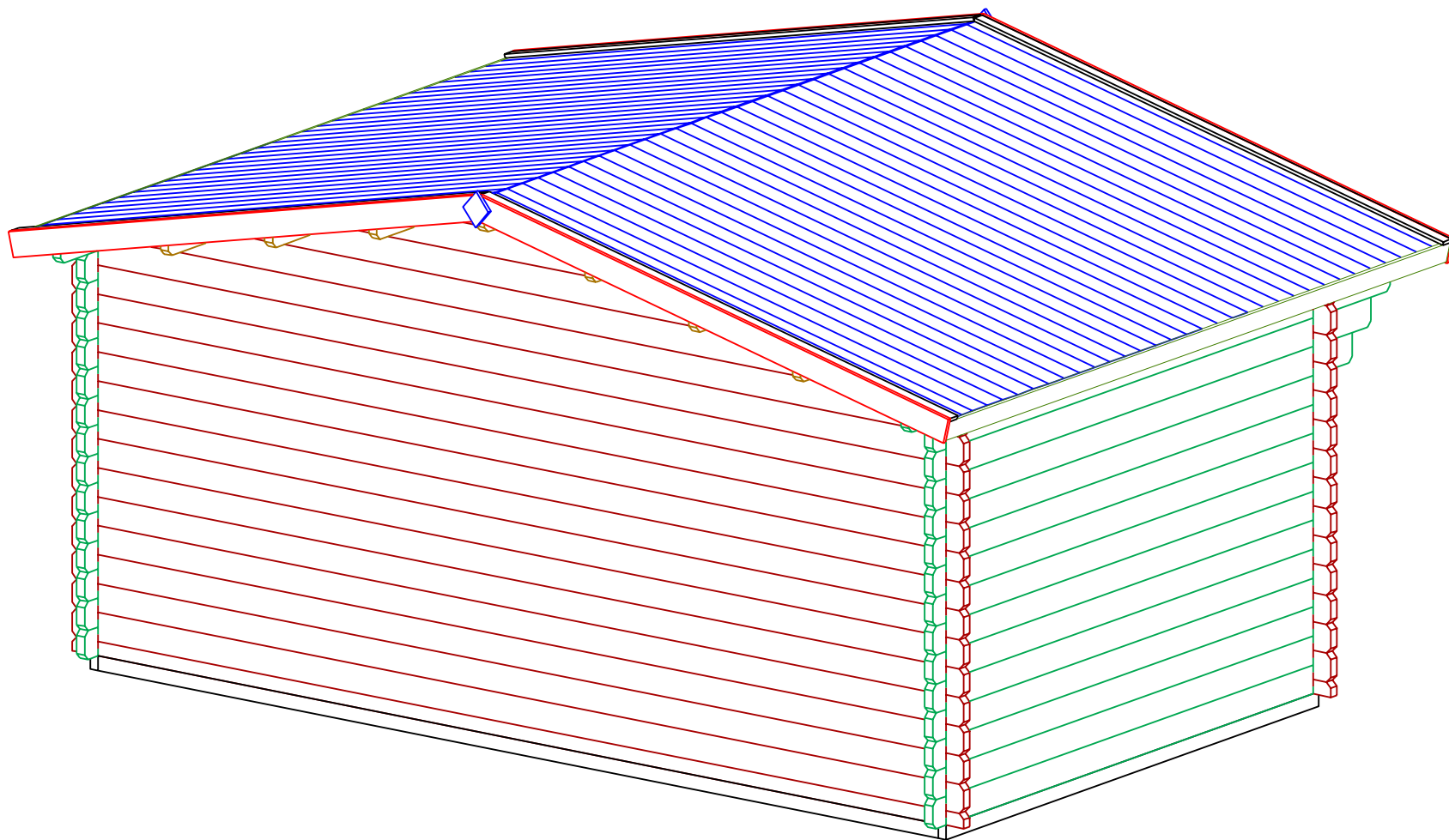

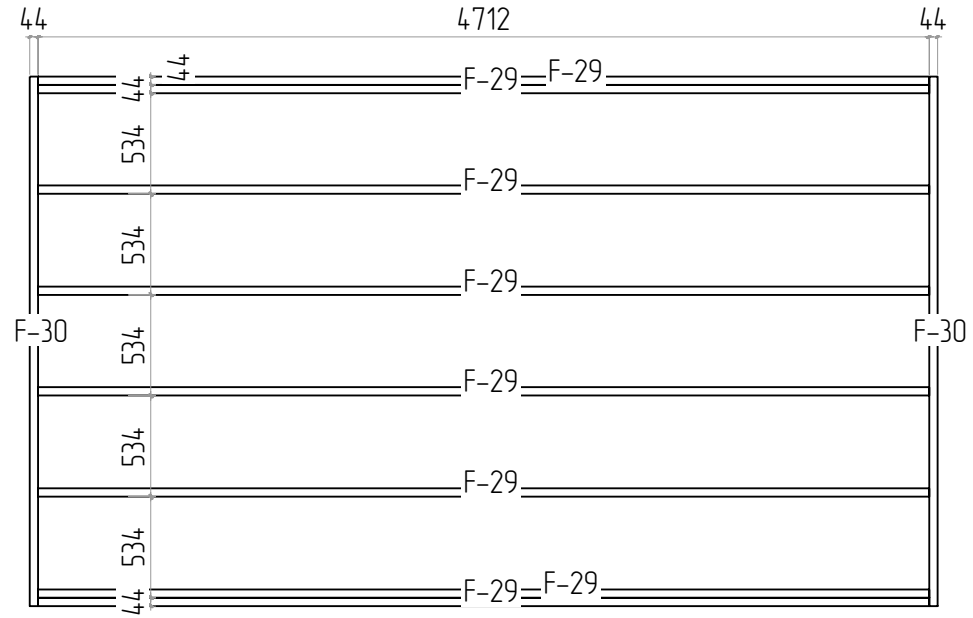

STAGE 2

Wissous 44 5X3

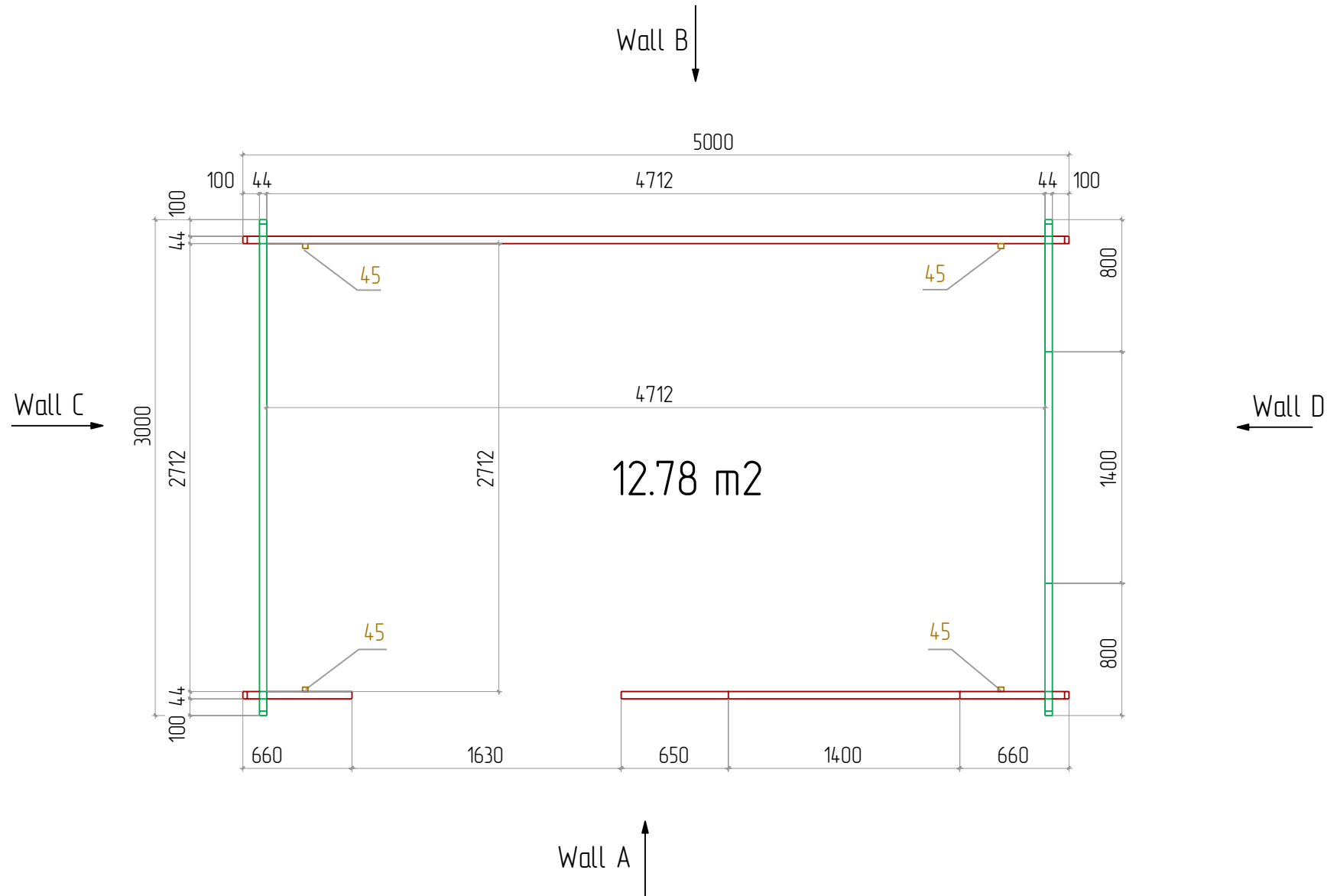

STAGE 2

W-A

Wissous 44 5X3

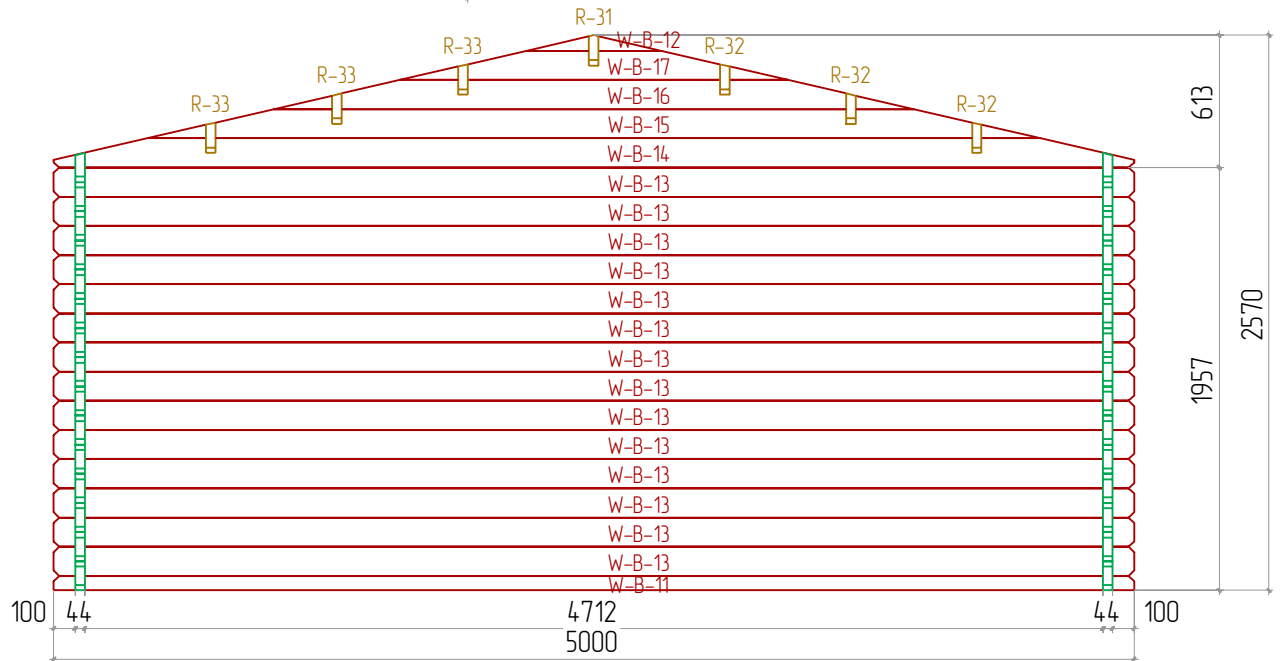
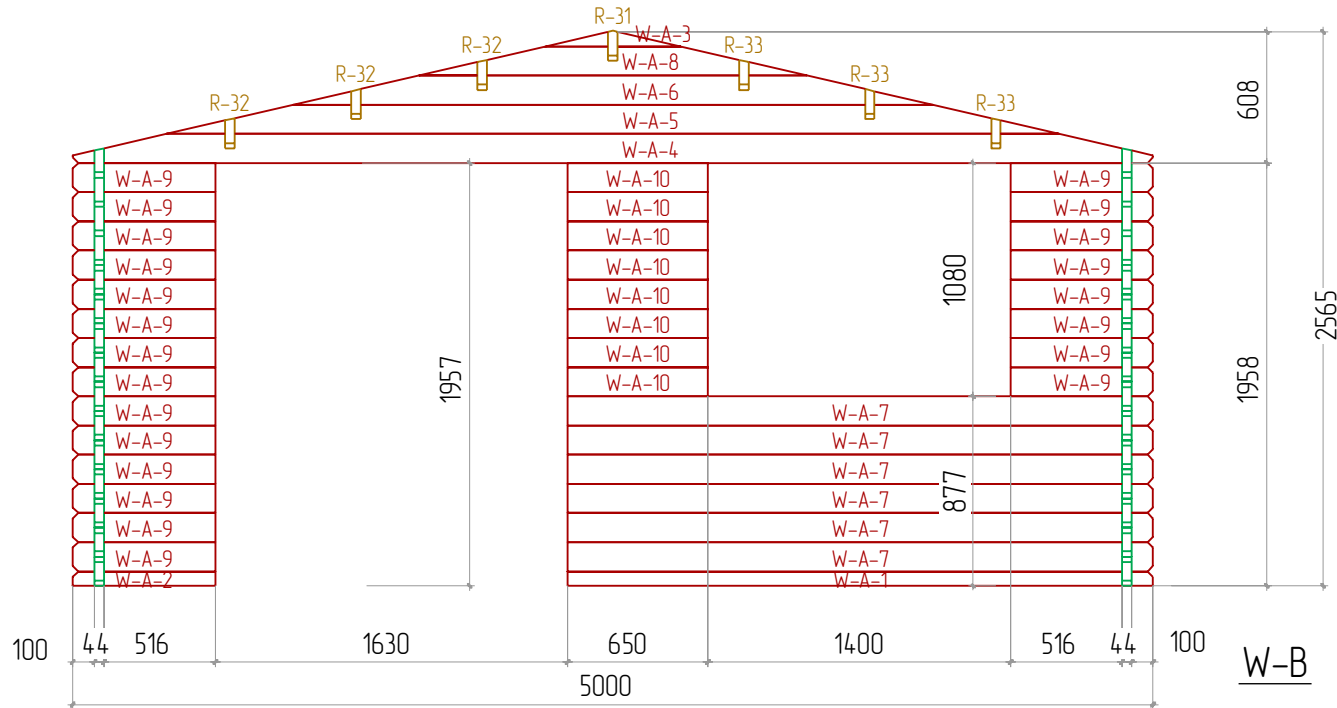

W-C

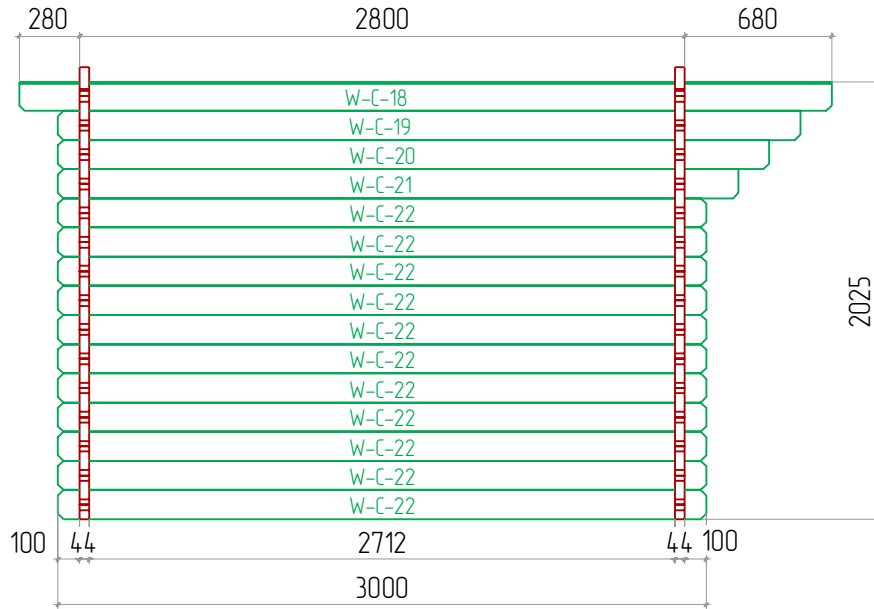

W-D

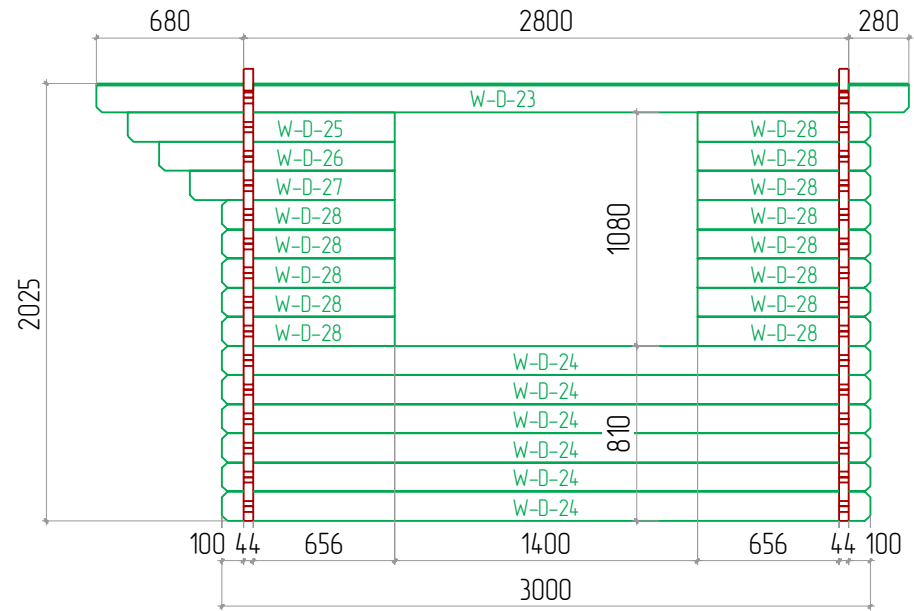

STAGE 3

Wissous 44 5X3

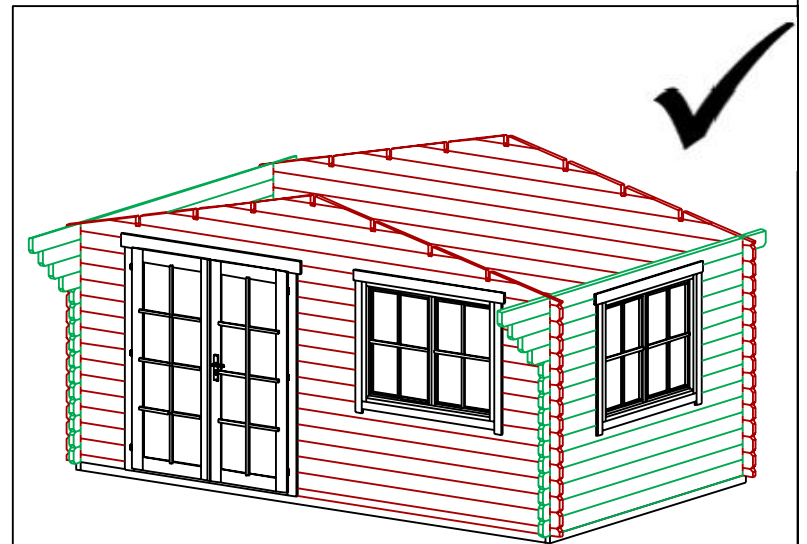
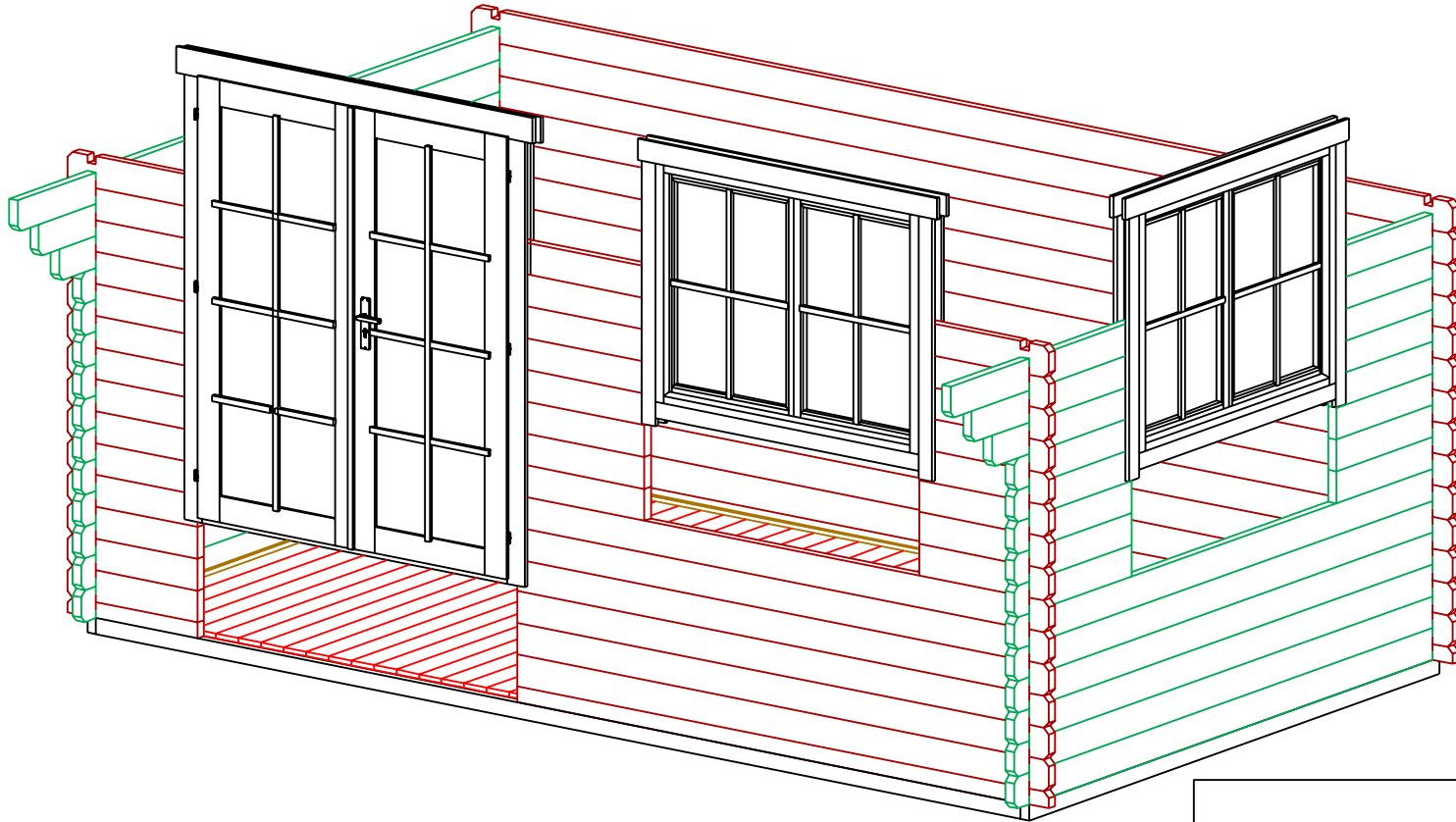

STAGE 4

Wissous 44 5X3

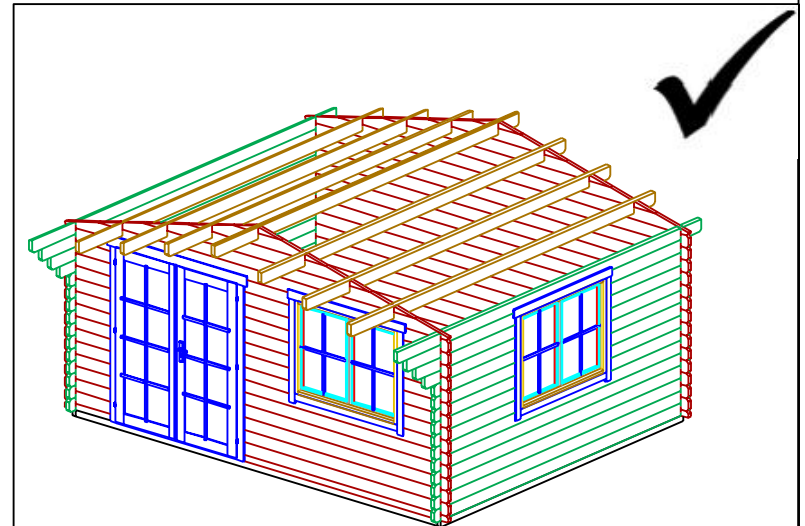
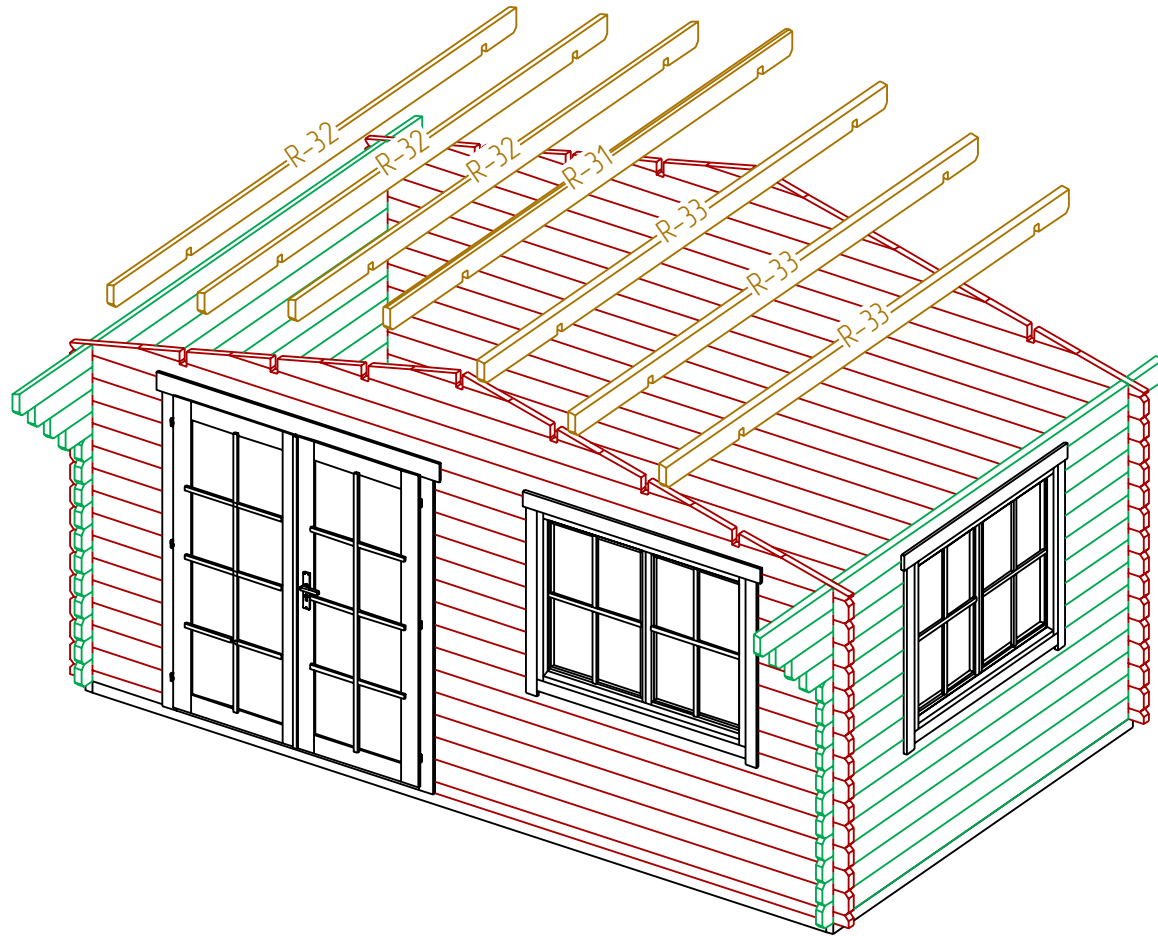

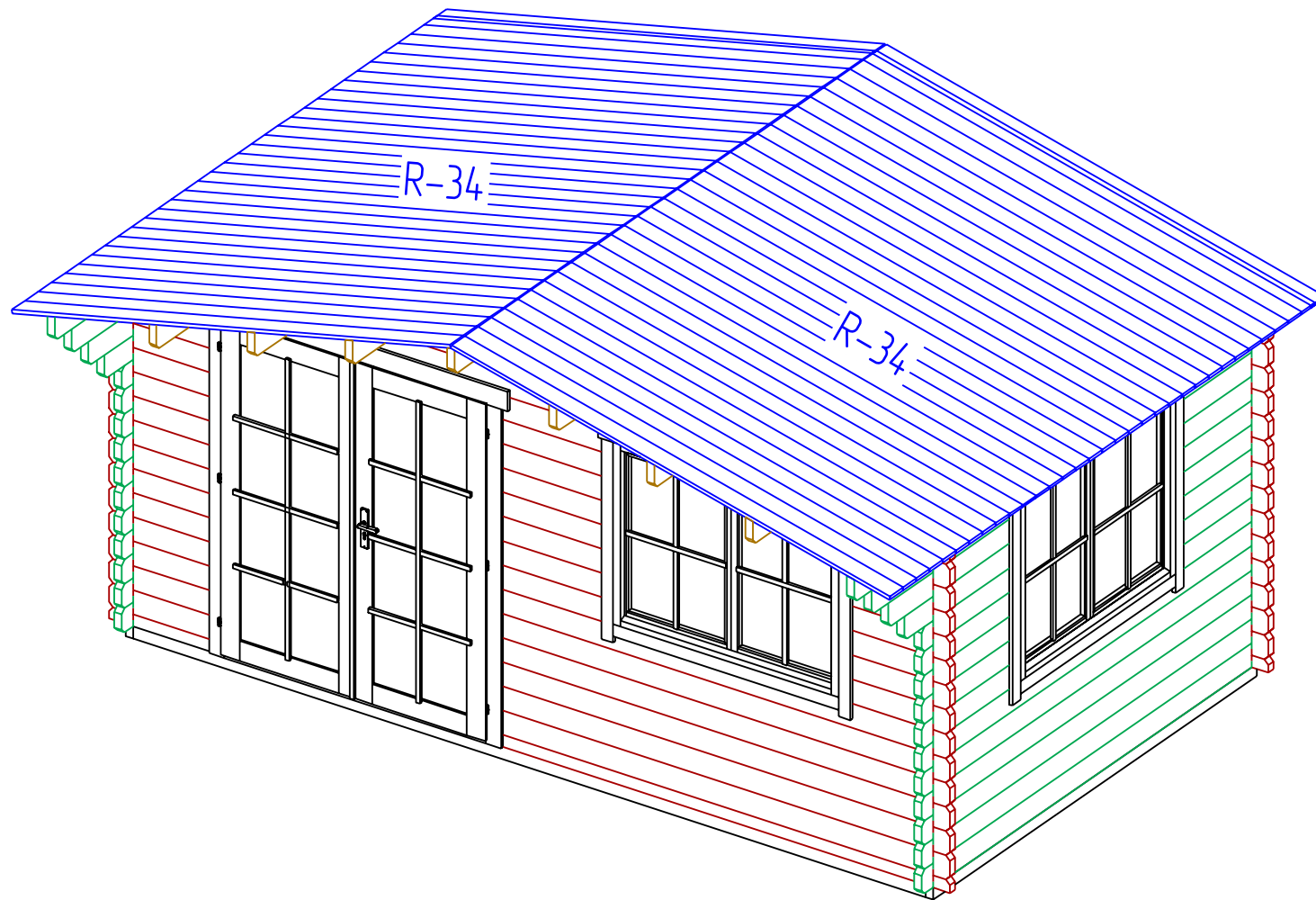

STAGE 6

Wissous 44 5X3

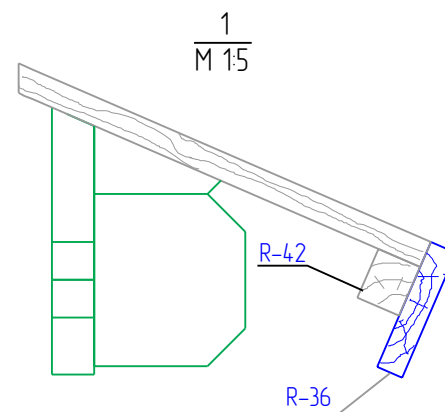
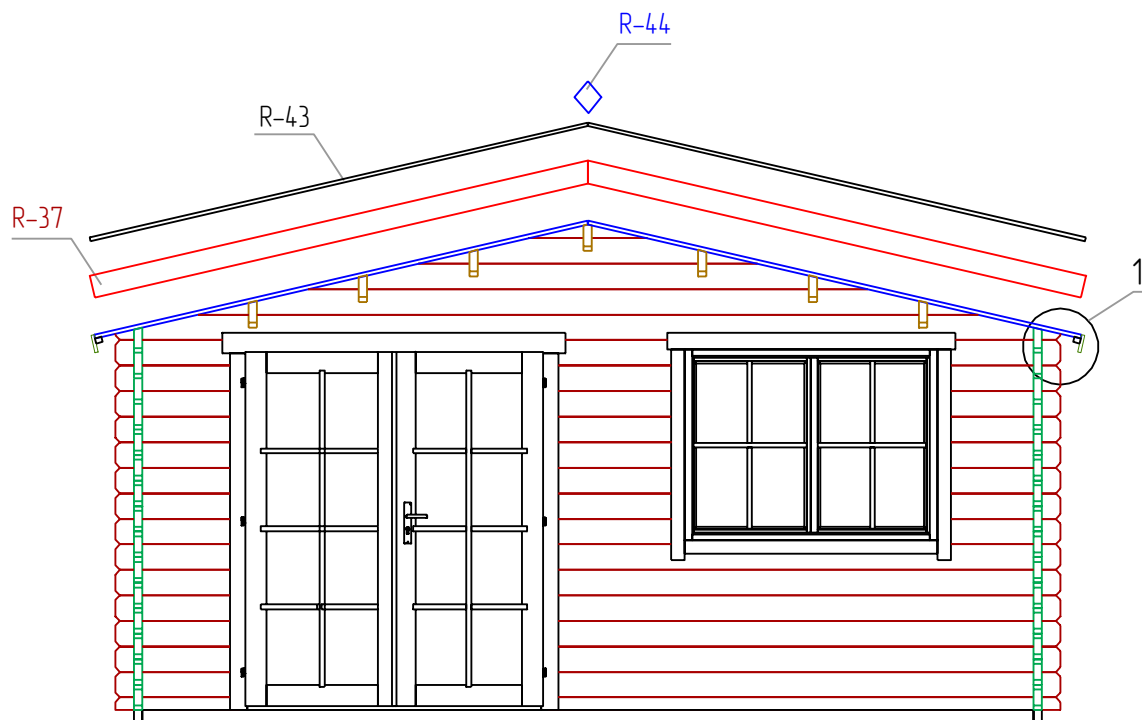

STAGE 6

Wissous 44 5X3

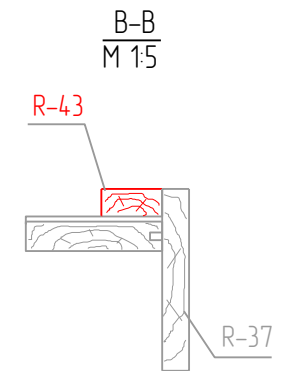
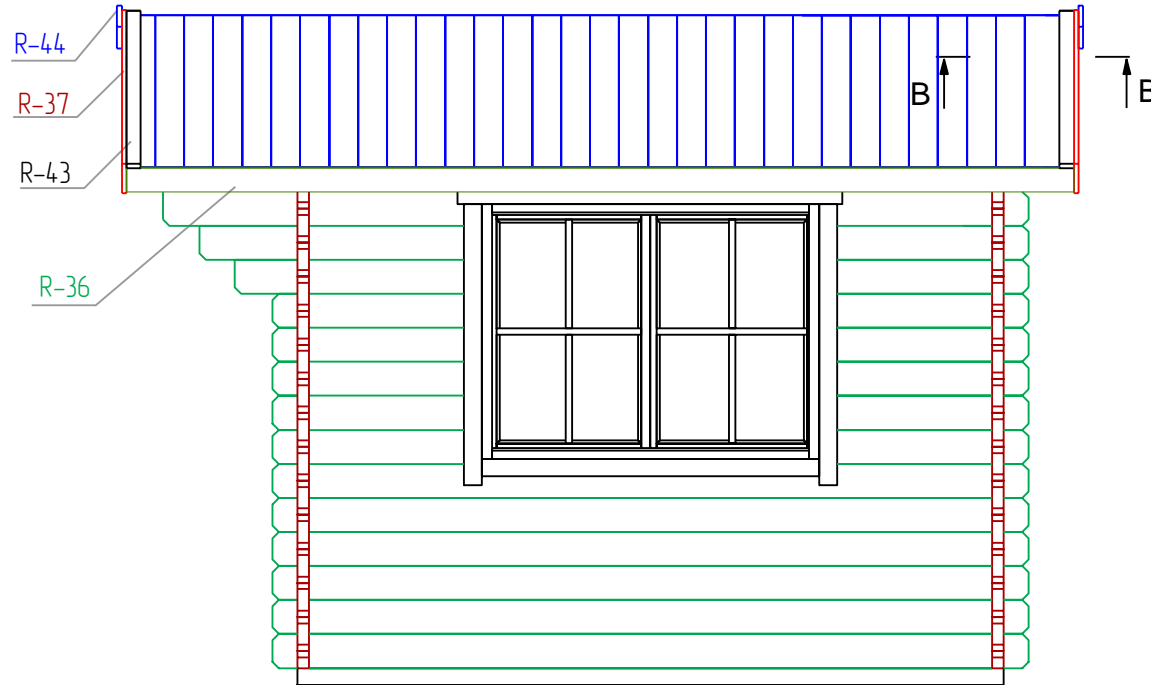

STAGE 7

Wissous 44 5X3

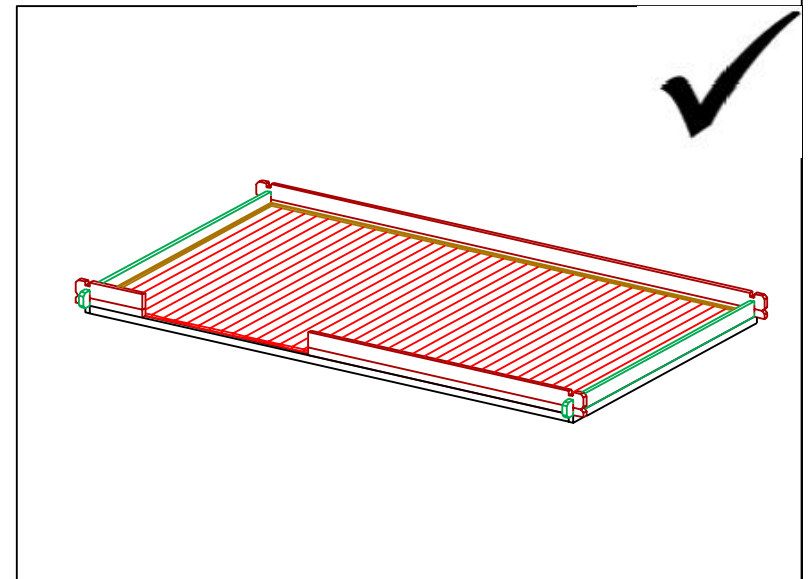
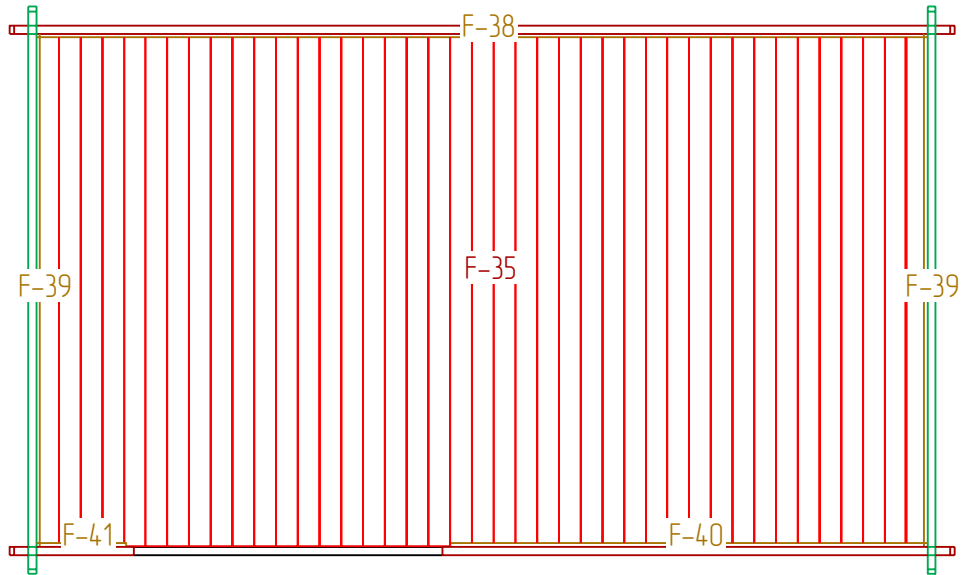

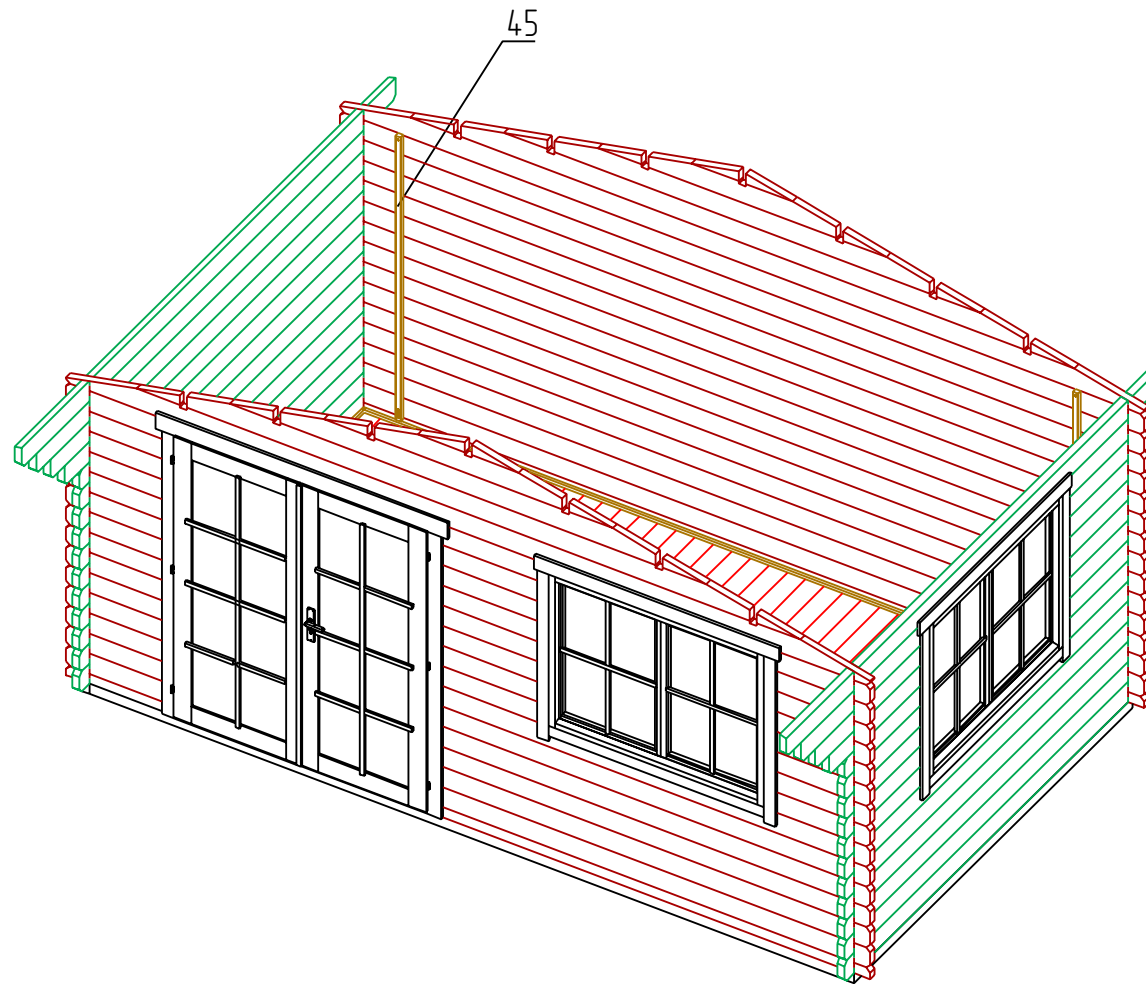

STAGE 1

F
NR: 30
PSC: 2
B/H: 44mm/68mm
L: 2800mm

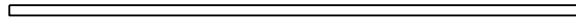

F
NR: 29
PSC: 8
B/H: 44mm/68mm
L: 4712mm

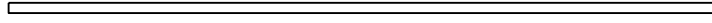

STAGE 2

W
NR: A 1
PSC: 1
B/H: 44mm/68mm
L: 2710mm

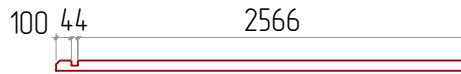

W
NR: A 2
PSC: 1
B/H: 44mm/68mm
L: 660mm

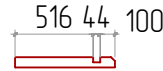

W
NR: A 7
PSC: 6
B/H: 44mm/135mm
L: 2710mm



W
NR: A 9
PSC: 22
B/H: 44mm/135mm
L: 660mm

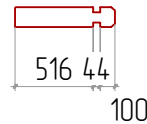

W
NR: A 10
PSC: 8
B/H: 44mm/135mm
L: 650mm



W
NR: B 11
PSC: 1
B/H: 44mm/68mm
L: 5000mm



W
NR: B 13
PSC: 15
B/H: 44mm/135mm
L: 5000mm

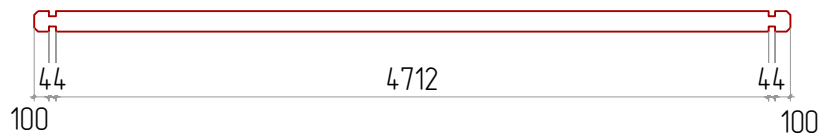



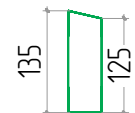







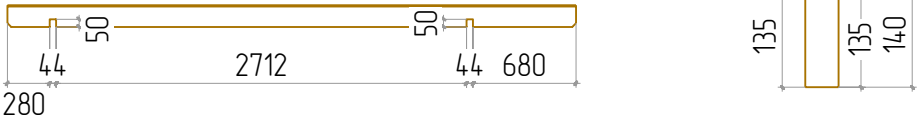
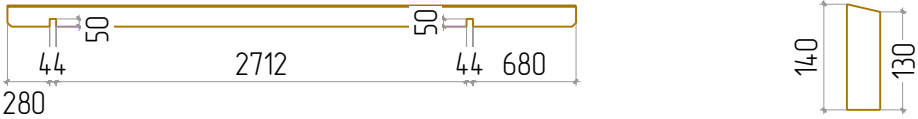
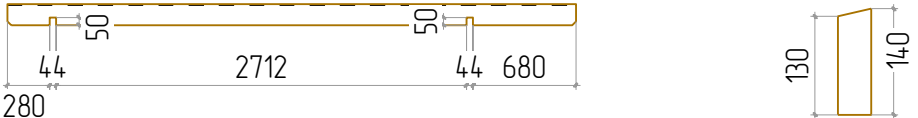

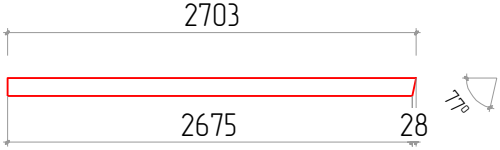
W
NR: C 18
PSC: 1
B/H: 44mm/135mm
L: 3760mm



WISSOUS 44 5X3

<p>W NR: C 19 PSC: 1 B/H: 44mm/135mm L: 3435mm</p>	
<p>W NR: C 20 PSC: 1 B/H: 44mm/135mm L: 3290mm</p>	
<p>W NR: C 21 PSC: 1 B/H: 44mm/135mm L: 3150mm</p>	
<p>W NR: C 22 PSC: 11 B/H: 44mm/135mm L: 3000mm</p>	
<p>W NR: D 23 PSC: 1 B/H: 44mm/135mm L: 3760mm</p>	
<p>W NR: D 24 PSC: 6 B/H: 44mm/135mm L: 3000mm</p>	
<p>W NR: D 25 PSC: 1 B/H: 44mm/135mm L: 1235mm</p>	
<p>W NR: D 26 PSC: 1 B/H: 44mm/135mm L: 1090mm</p>	
<p>W NR: D 27 PSC: 1 B/H: 44mm/135mm L: 950mm</p>	
<p>W NR: D 28 PSC: 13 B/H: 44mm/135mm L: 800mm</p>	

<p>W NR: A PSC: 1</p>	
<p>W NR: B PSC: 1</p>	
<p>STAGE 3</p>	
<p>Door PSC: 1 B/H: 1630mm/1958mm</p>	
<p>Window PSC: 2 B/H: 1400mm/1080mm</p>	
<p>STAGE 4</p>	
<p>R NR: 31 PSC: 1 B/H: 44mm/140mm L: 3760mm</p>	
<p>R NR: 32 PSC: 3 B/H: 44mm/140mm L: 3760mm</p>	
<p>R NR: 33 PSC: 3 B/H: 44mm/140mm L: 3760mm</p>	
<p>STAGE 5</p>	
<p>R NR: 34 PSC: 67 B/H: 20mm/115mm L: 2675mm</p>	
<p>STAGE 6</p>	
<p>R NR: 36 PSC: 2 B/H: 18mm/95mm L: 3760mm</p>	
<p>R NR: 37 PSC: 4 B/H: 18mm/120mm L: 2703mm</p>	

<p>R NR: 42 PSC: 2 B/H: 28mm/34mm L: 3760mm</p>	
<p>R NR: 43 PSC: 4 B/H: 18mm/58mm L: 2699mm</p>	
<p>R NR: 44 PSC: 2 B/H: 18mm/120mm L: 120mm</p>	
<p>STAGE 7</p>	
<p>F NR: 35 PSC: 42 B/H: 20mm/115mm L: 2708mm</p>	
<p>F NR: 38 PSC: 1 B/H: 18mm/20mm L: 4712mm</p>	
<p>F NR: 39 PSC: 2 B/H: 18mm/20mm L: 2712mm</p>	
<p>F NR: 40 PSC: 1 B/H: 18mm/20mm L: 2523mm</p>	
<p>F NR: 41 PSC: 1 B/H: 18mm/20mm L: 473mm</p>	
<p>STAGE 8</p>	
<p>NR: 45 PSC: 4 B/H: 28mm/34mm L: 1900mm</p>	